

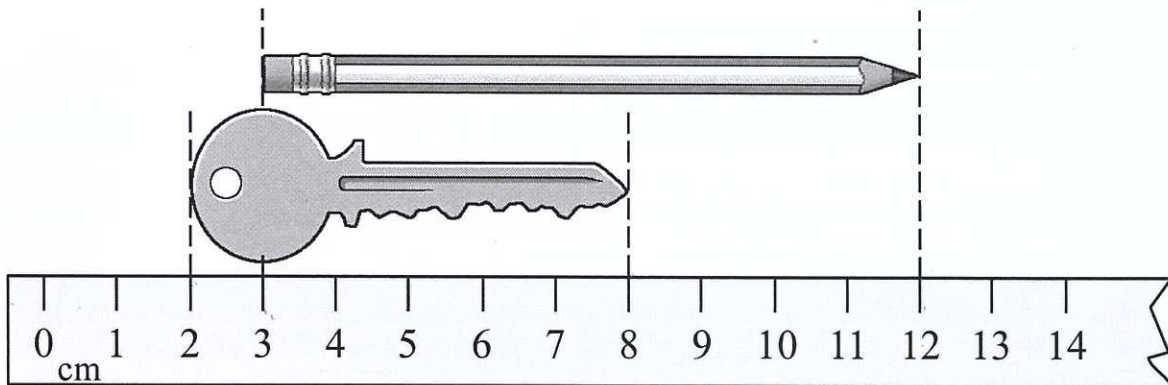





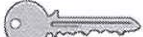

14 Centimetre and Centimetre Ruler

Look at the picture and answer the questions.



1.  is _____ cm long.
 2.  is _____ cm long.
 3.  is _____ cm (longer / shorter) than .
- (Circle the answer)

Measure and compare the length of the ribbons.

4.  is about _____ cm long.
 -  is about _____ cm long.
 -  is about _____ cm (longer / shorter) than .
- (Circle the answer)